

Montageanleitung Montážny návod MANHATTAN

Type/Typ **71/72/73/74/75/80**

MN 170/01

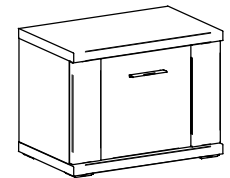
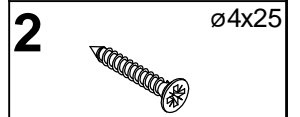
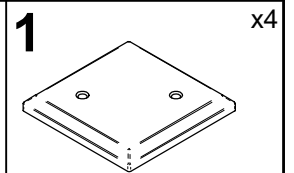

Typ 74

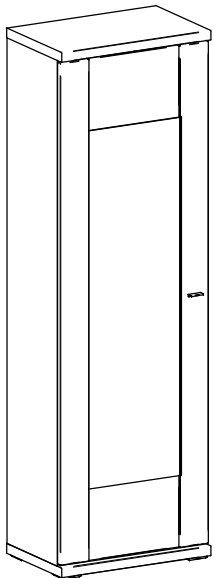

Typ 71

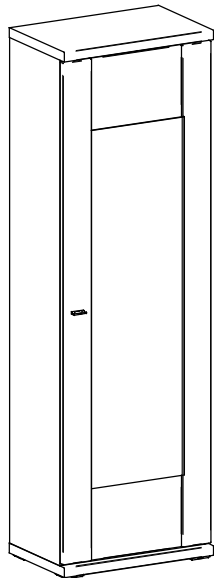

Typ 72

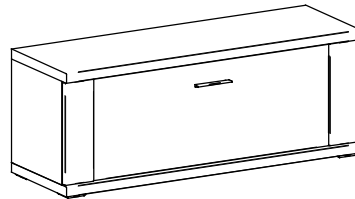

Typ 80

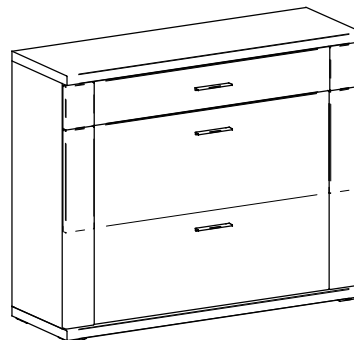

Typ 73

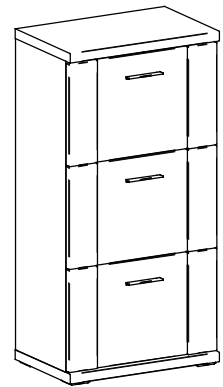

Typ 75

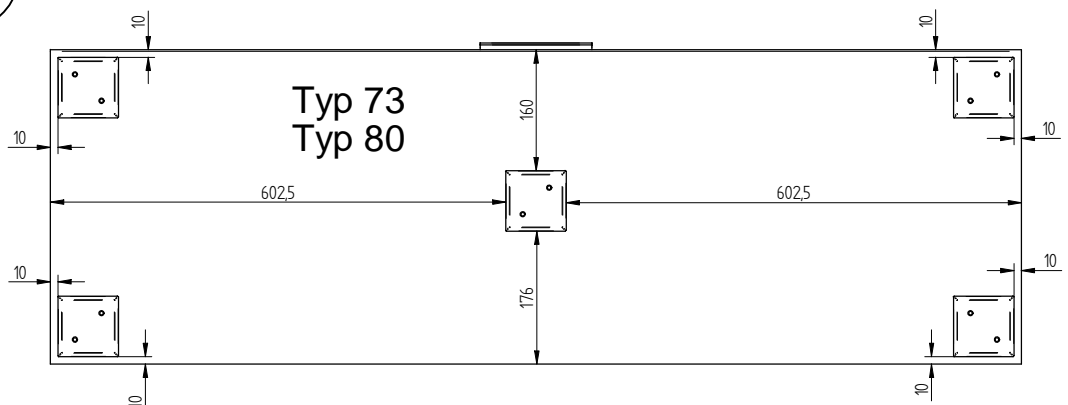
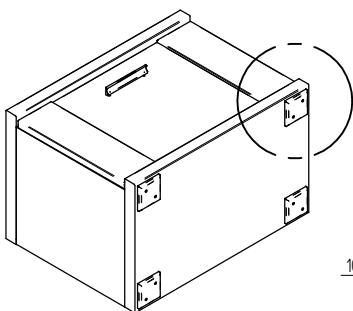
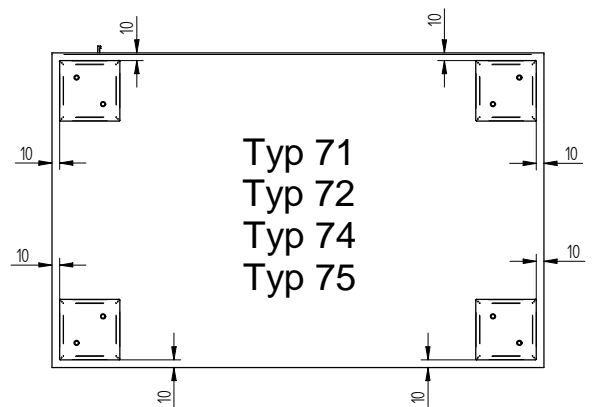
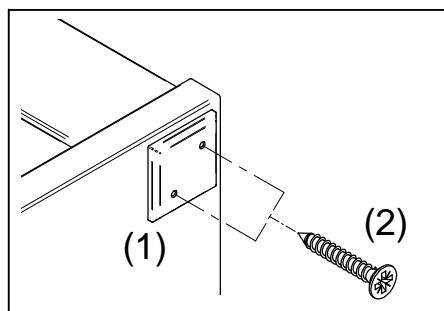

2 SICHERHEITSWINKEL (VERHINDERT DAS UMKIPPEN DES SCHRANKES) BEZPEČNOSTNÝ VINKEL (ZABRAŇUJE PREVRHNUTIU SKRINKY)

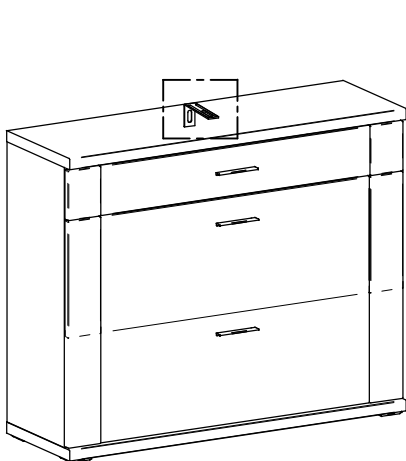
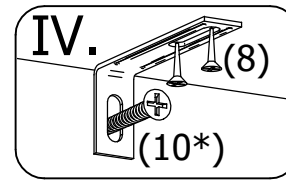
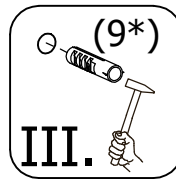
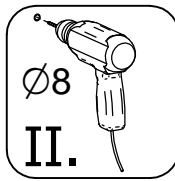
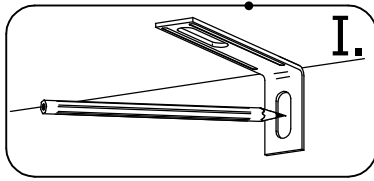

Typ 73

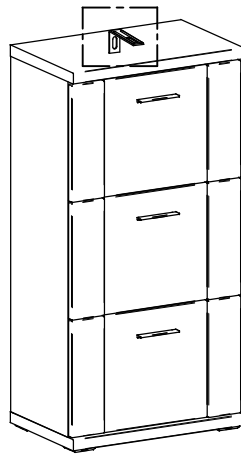

Typ 75

<p>3 1x</p>	<p>4 2x</p> <p>ø3,5x15</p>
<p>5</p> <p>ø10x50</p>	<p>6</p> <p>ø5x60</p>
<p>* NICHT BEINHÄLTET IM BESCHLAGBEUTEL! * NIE JE SÚČASŤOU KOVANIA!</p>	

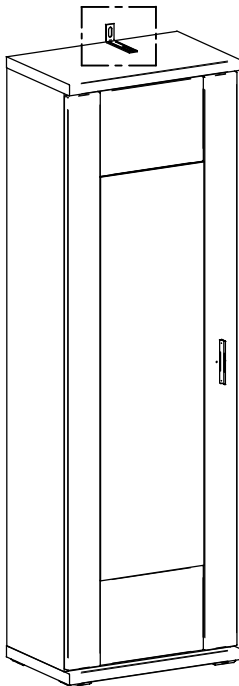

Typ 71

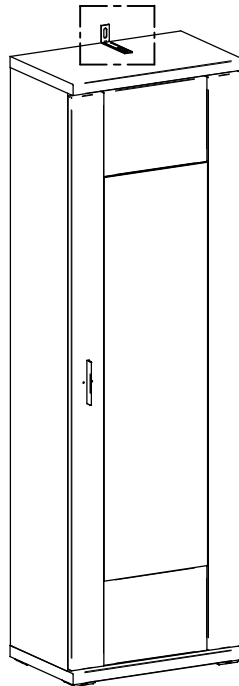

Typ 72

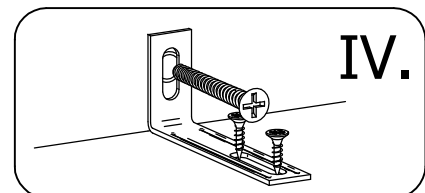
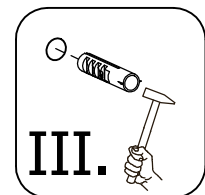
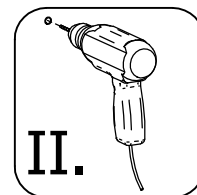
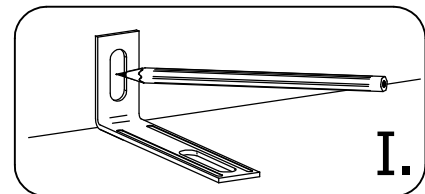

WICHTIGER HINWEIS

Schraube (4*) ist für die Befestigung des Sicherheitswinkels (3*) auf dem Schrank bestimmt. Des weiteren werden Sie noch Schraube (6) und Dübel (5) für die Befestigung des Sicherheitswinkels in die Mauer (Wand) gebrauchen. Schraube und Dübel wählen Sie bitte nach dem Material, aus dem die Mauer (Wände) bestehen. Falls Sie sich nicht sicher sind, welche Schraube (6) und Dübel (5) Sie gebrauchen, wenden Sie bitte an nächsten Fachhandel.

DÔLEŽITÉ UPOZORNENIE

Skrutka (4*) je určená na upevnenie bezpečnostného kovania (3*) ku skrinke. Okrem toho budete potrebovať skrutku (6) a hmoždinku (5) na pripevnenie kovania k stene. Tieto si zvolte podľa druhu steny. Ak nie ste si istý, aký druh skrutky a hmoždinky potrebujete, kontaktujte najbližšie železiarstvo.

3 MONTAGE DES GRIFFES / MONTÁŽ ÚCHYTKY

Typ 71,72,73,74,75,80

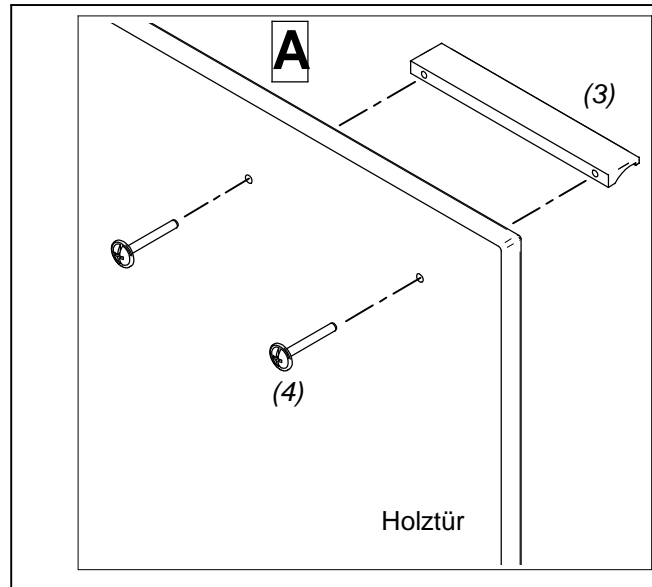
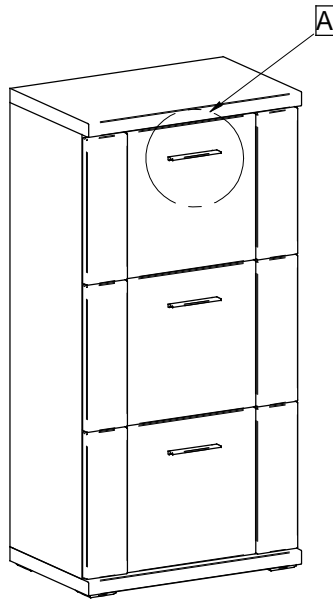
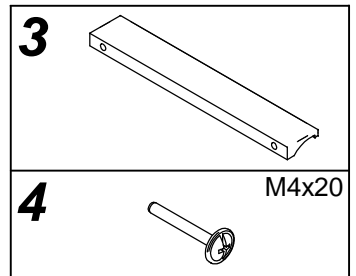

Einstellung von Türen / Nastavenie dverí

<p>Schritt krok 1-3</p> <p>Schritt krok 2</p> <p>Schritt krok 1-3</p>	<p>Schritt krok 1-3</p> <p>Schritt krok 2</p>	<p>Schritt krok 1</p> <p>Schritt krok 1</p>
<p>1. Die Schraube B lösen 2. Tür in der Höhe einstellen 3. Die Schraube B zuziehen</p> <p>1. skrutku B povoliť 2. dvere výškovo nastaviť 3. skrutku B dotiahnuť</p>	<p>1. Die Schraube A lösen 2. Tür in der Tiefe einstellen 3. Die Schraube A zuziehen</p> <p>1. skrutku A povoliť 2. dvere hlbkovo nastaviť 3. skrutku A dotiahnuť</p>	<p>1. Tür seitligs mit Schraube C einstellen</p> <p>1. dvere stranovo skrutkou C nastaviť</p>
<p>+ 2 mm - 2 mm</p>	<p>+ 3 mm - 1 mm</p>	<p>+ 5 mm - 1,5 mm</p>

Montageanleitung Montážny návod

MANHATTAN

Type/Typ **76**
MN 170/02

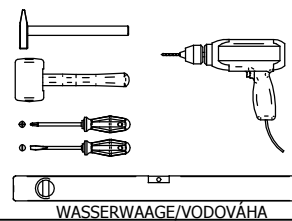
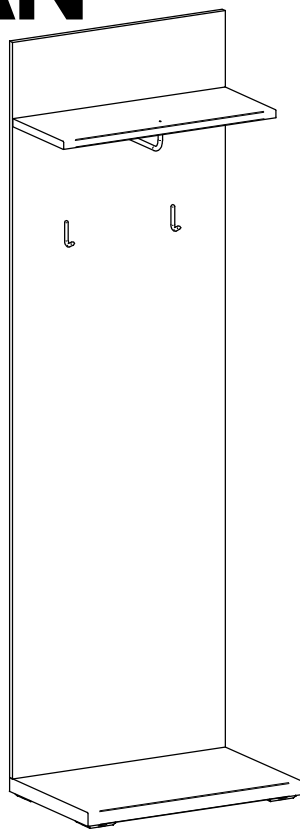

1



x2

2



ø6,3x11
x4

3

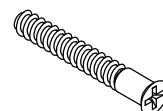

ø7x50
x4

4



ø8x35
x3

5

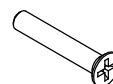

ø5x40
x6

6



ø5x50
x2

7

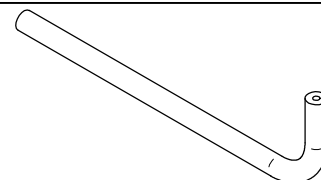

x1

8*

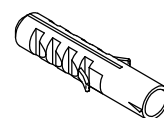

ø10x50
x2

* NICHT BEINHALTET IM BESCHLAGBEUTEL!
* NIE JE SÚČASŤOU KOVANIA!

9

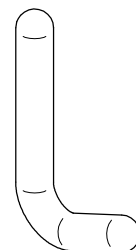

x2

10

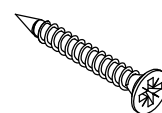

ø4x30
x8

11

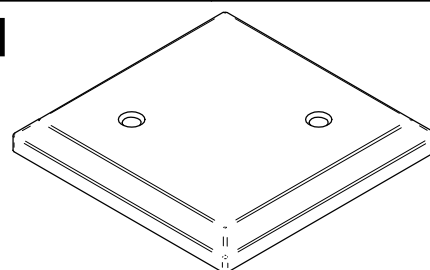

x4

SERVISKARTE / SERVISNÁ KARTA

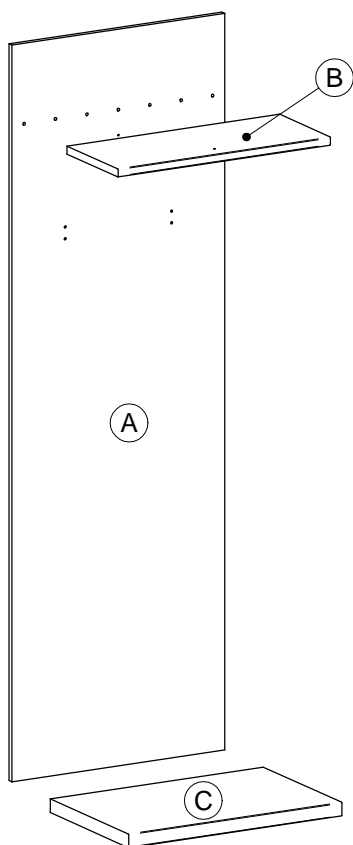

1

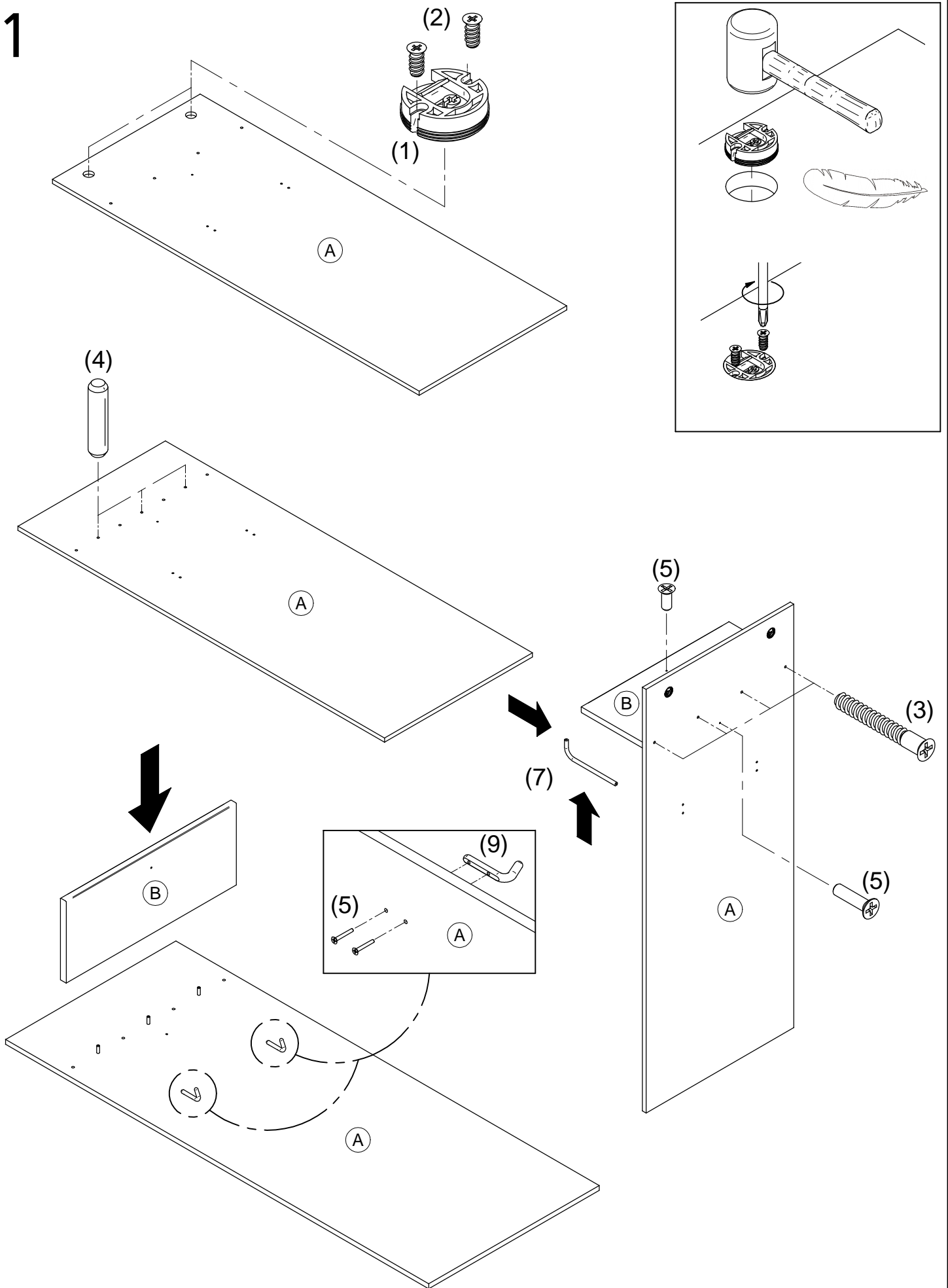

Achtung! Bitte nur Schraubenzieher zu verwenden, keinen Akkuschauber!
Pozor! Prosím skrutkujte manuálne, nie akuskrutkovačom.

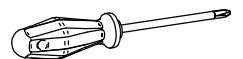

2

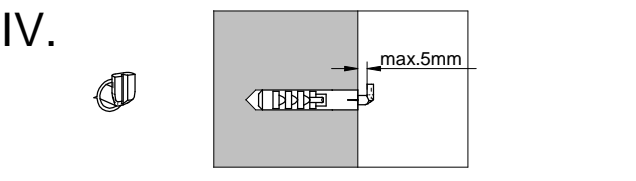
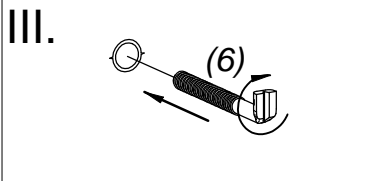
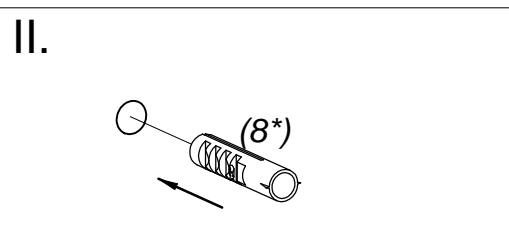
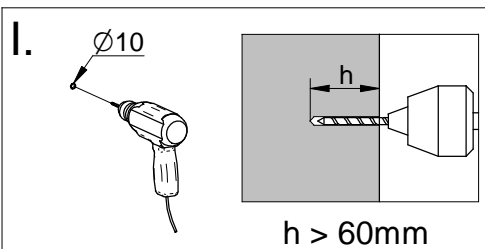
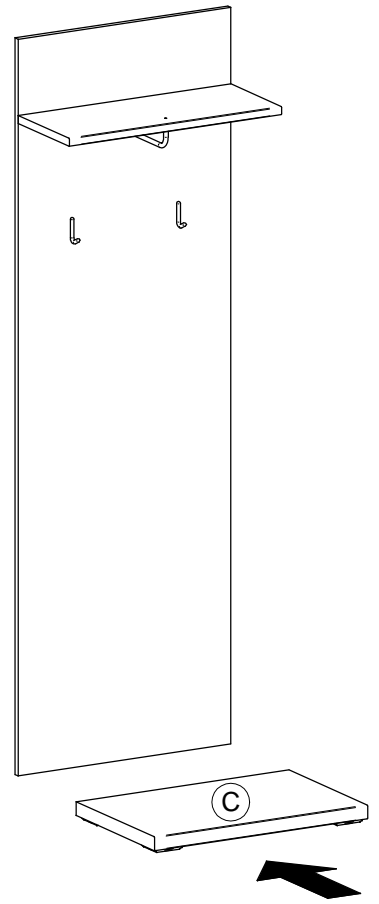
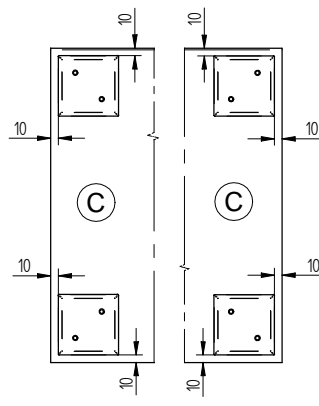
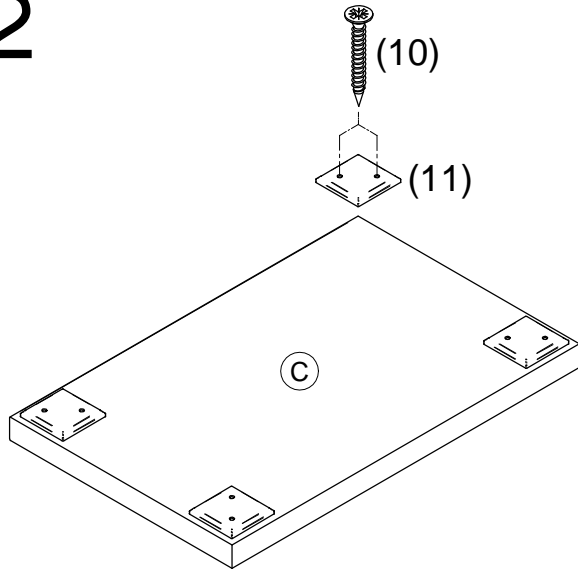

*Befestigungsdübel ist kein Bestandteil der Verpackung. Es ist nötig, einen geeigneten Dübel zu wählen, je nach der Tragfähigkeit und Zusammensetzung der Mauer, an die Schränke gehängt werden.
 Falls Sie sich nicht sicher sind, welcher Typ von Dübel Sie brauchen, nehmen Sie Kontakt mit dem nächsten Fachhandel auf.

*Upevňovacia hmoždinka nie je súčasťou balenia. Je nutné, zvoliť vhodnú hmoždinku vzhľadom na nosnosť a typ steny, na ktorú nábytok vešiate.
 Ak nie ste si istý, aký druh hmoždinky potrebujete, kontaktujte najbližšie zeleziarstvo.

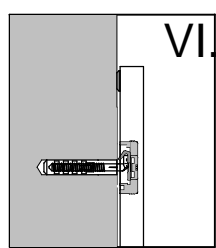
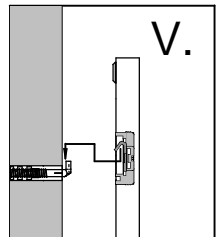

Höheneinstellung / výškové nastavenie

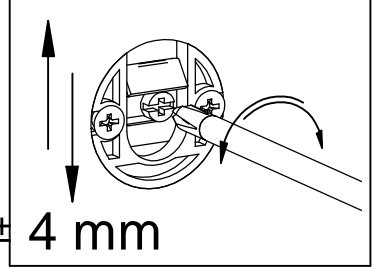

Bohrung plan / Vrtací plán

