

MONTAGEANLEITUNG DES ZUSAMMENSTELLUNG MONTÁŽNY NÁVOD NA ZOSTAVU

CARIBIC

MN 181/01

BEACHTEN SIE BITTE, DASS BEI NICHT FACHGEMÄSSER MONTAGE, BZW. BEI ÜBERMÄSSIGER ODER UNGEEIGNETER BELASTUNG DES MÖBELS GEGENSTÄNDE ODER PERSONEN KANN DAS MÖBEL GEFÄHRLICH SEIN!



PROSÍM, MAJTE NA PAMÄTI, ŽE PRI NEODBORNEJ MONTÁŽI, PRÍPADNE NADMERNOM ALEBO NEVHODNOM ZAŤAŽOVANÍ NÁBYTKU PREDMETMI, OSOBNAMI MÔŽE BYŤ NÁBYTOK NEBEZPEČNÝ!

1 MONTAGE DES FÜßES / MONTÁŽ NOHY

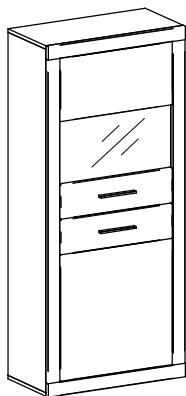

Typ 01

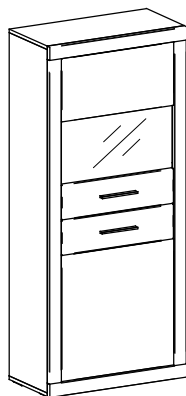

Typ 02

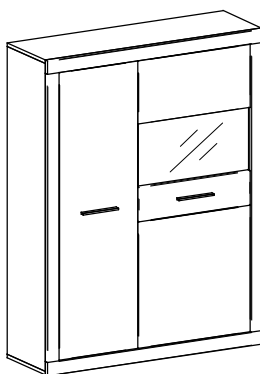

Typ 03

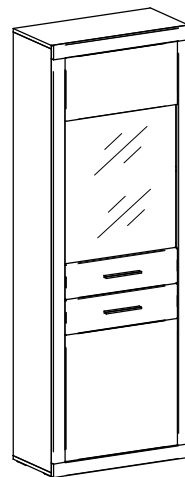

Typ 05

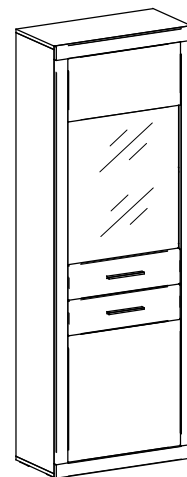

Typ 06

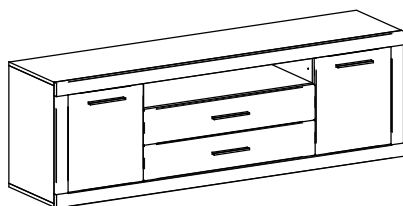

Typ 31

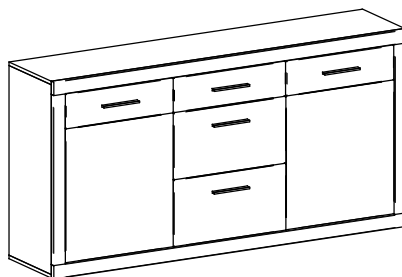

Typ 51

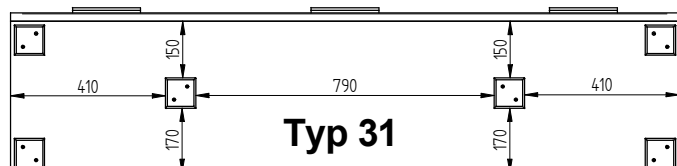
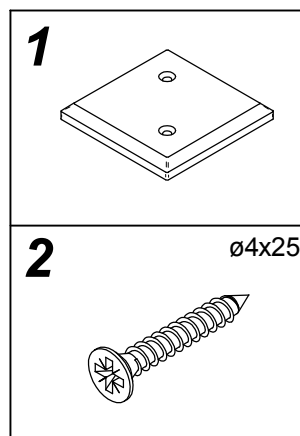

Typ 31

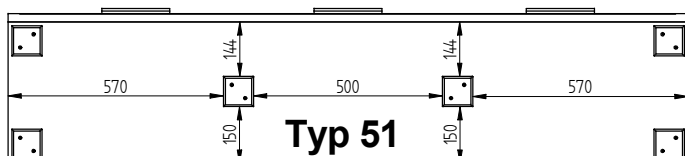

Typ 51

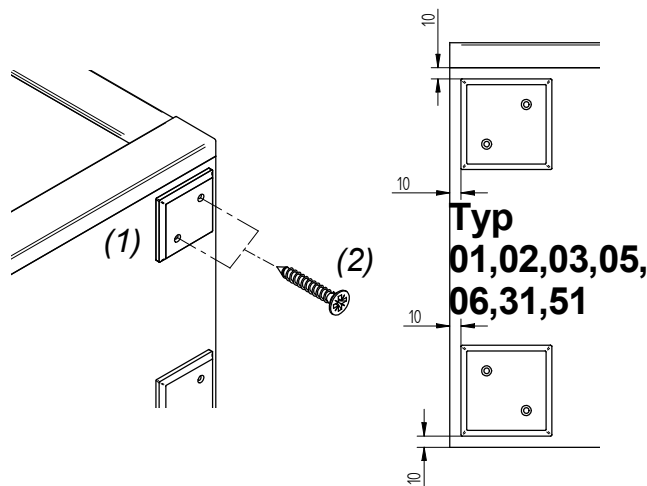

Typ
01,02,03,05,
06,31,51

2

MONTAGE DES GRIFFES / MONTÁŽ ÚCHYTKY

Typ 01,02,03,05,06,31,51

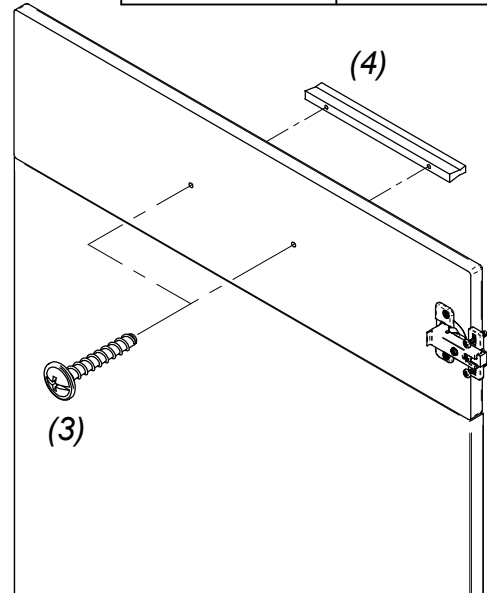
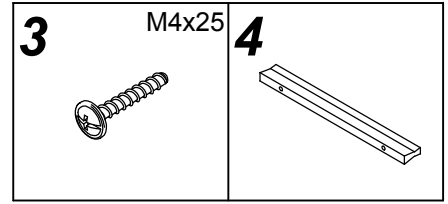
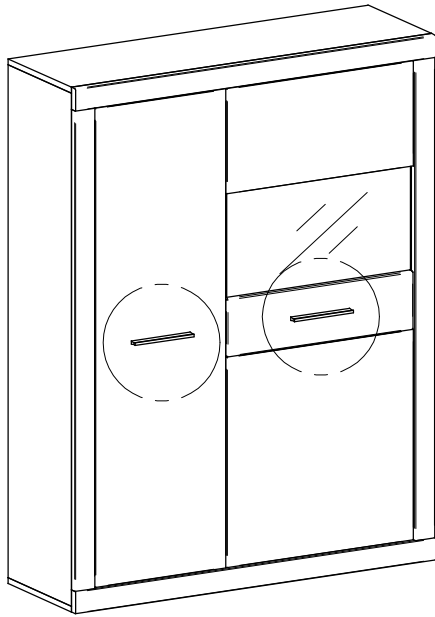

3

SICHERHEITSWINKEL (VERHINDERT DAS UMKIPPEN DES SCHRANKES) BEZPEČNOSTNÝ VINKEL (ZABRAŇUJE PREVRHNUTIU SKRINKY)

Typ 05/06

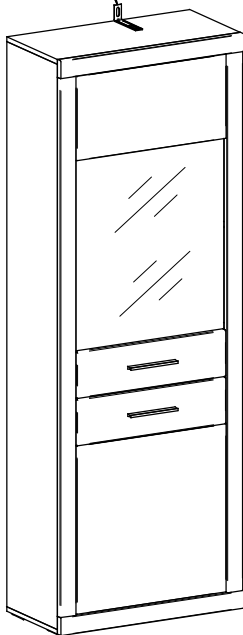

* NICHT BEINHALTET IM BESCHLAGBEUTEL!
* NIE JE SÚČASŤOU KOVANIA!

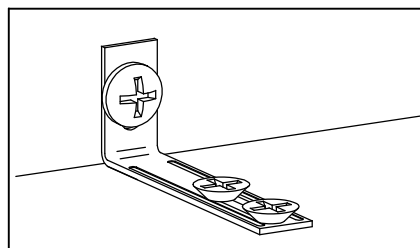
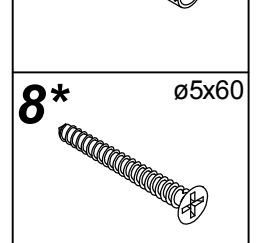
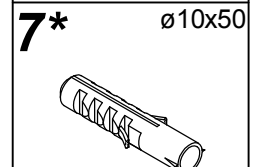
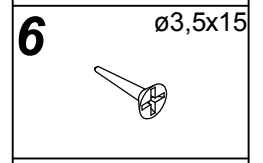
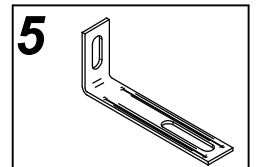
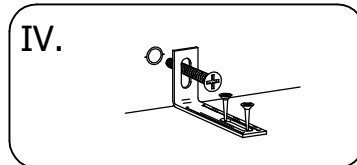
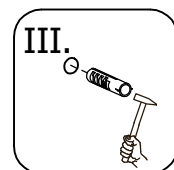
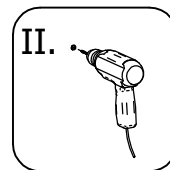
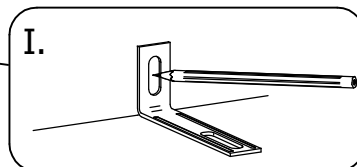

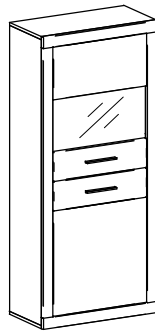
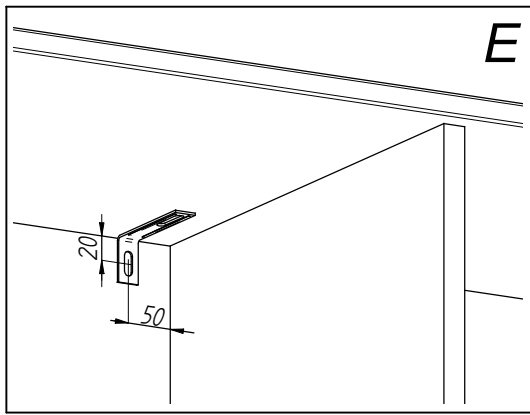

01/02

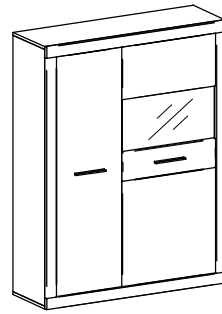

03

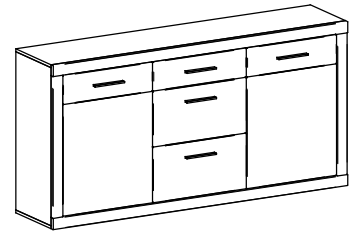

51

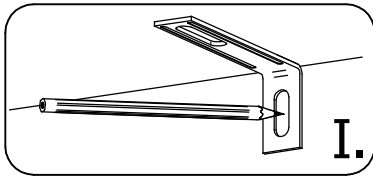

I.

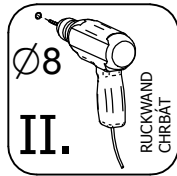

II.



III.

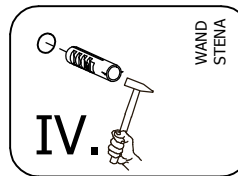

IV.

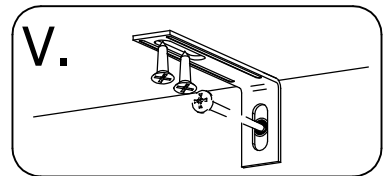

V.

WICHTIGER HINWEIS

Schraube (8) ist für die Befestigung des Sicherheitswinkels (7) auf dem Schrank bestimmt. Des weiteren werden Sie noch Schraube (10) und Dübel (9) für die Befestigung des Sicherheitswinkels in die Mauer (Wand) gebrauchen. Schraube und Dübel wählen Sie bitte nach dem Material, aus dem die Mauer (Wände) bestehen. Falls Sie sich nicht sicher sind, welche Schraube (10) und Dübel (9) Sie gebrauchen, wenden Sie bitte an nächsten Fachhandel.



DÔLEŽITÉ UPOZORNENIE

Skrutka (8) je určená na upevnenie bezpečnostného kovania (7) ku skrinke. Okrem toho budete potrebovať skrutku (10) a hmoždinku (9) na pripevnenie kovania k stene. Tieto si zvolte podľa druhu steny. Ak nie ste si istý, aký druh skrutky a hmoždinky potrebujete, kontaktujte najbližšie železiarstvo.

Einstellung von Türen / Nastavenie dverí

<ol style="list-style-type: none"> 1. Die Schraube B lösen 2. Tür in der Höhe einstellen 3. Die Schraube B zuziehen <ol style="list-style-type: none"> 1. skrutku B povoliť 2. dvere výškovo nastaviť 3. skrutku B dotiahnuť 	<ol style="list-style-type: none"> 1. Tür in der Tiefe mit Schraube C einstellen <ol style="list-style-type: none"> 1. dvere hlbkovo nastaviť skrutkou C 	<ol style="list-style-type: none"> 1. Die Schraube A lösen 2. Tür seitligs einstellen 3. Die Schraube A zuziehen <ol style="list-style-type: none"> 1. skrutku A povoliť 2. dvere stranovo nastaviť 3. skrutku A dotiahnuť
<p>+ 2 mm - 2 mm</p>	<p>+ 5 mm - 1,5 mm</p>	<p>+ 3 mm - 1 mm</p>

4 EINSCHIEBUNG VON EINLEGEBODEN / VKLADANIE POLÍC.

